

# DHI-ASI7214X

## Face Recognition Access Controller



- 2.5D curved screen
- 7 Inch LCD display with resolution of 1024×600
- 2 MP CMOS, WDR
- Vehicle level LCD whose working temperature is -30°C to 50°C
- IP65 (Silicone sealant is needed. For details, see the quick start guide.)
- Auto fill light reduces light pollution
- Can hold 100,000 users, 100,000 face images, 10,000 fingerprints, 100,000 cards, 100,000 password, 50 administrators, and 300,000 records
- Support face, fingerprint, IC card, password unlock and unlock through their combinations
- With face detection box; the largest face among faces that appear at the same time is recognized first; the maximum face size can be configured on the web
- Face-camera distance: 0.3 m–2.0 m; human height: 0.9 m–2.4 m (lens-ground distance: 1.4 m)
- With face recognition algorithm, the access controller can recognize more than 360 positions on human face
- Support liveness detection
- Face recognition speed: 0.2 s per face
- Accurate recognition in backlight and front light
- Various unlock status display modes protect user privacy
- Support duress alarm, tamper alarm, intrusion alarm, door contact timeout alarm, and illegal card exceeding threshold alarm
- Support general users, patrol users, VIP users, guest users, and special users

### Technical Specification

#### System

Main Processor	Embedded Processor
Internet Protocol	IPv4, RTSP, RTP, TCP, UDP, P2P
OSDP Protocol	Yes
Interoperability	ONVIF; CGI
SDK and API	Support SDK

#### Basic

Display	7 inch display
Screen Type	Capacitive screen
Resolution	600(H)×1024(V)
Camera	1/2.8" 2MP CMOS high definition WDR dual camera
WDR	120dB

Light Compensation	Auto white light Auto IR light
Status Indicator	1 indicator light. Red: Error; Green: Normal; Blue: Working
Voice Prompt	Yes
Housing Material	Aluminium alloy/tempered glass/PC

#### Function

Unlock Mode	Card/Remote/Fingerprint/Password/Face unlock and unlock through their combinations
Card Reading Type	IC card
Period List	128
Holiday Period	128
First-Card Unlock	Yes
Remote Verification	Yes
Peripheral Card Reader	1 RS-485, 1 Wiegand

Multiple Authentication	Yes
Real-Time Surveillance	Yes
Web Configuration	Yes
<b>Performance</b>	
Card Reading Distance	1cm–3cm
Face Recognition Range	Face-camera distance: 0.3 m–2.0 m Human height: 0.9m–2.4 m
Face Verification Accuracy	≥99.5%
Face Recognition Time	0.2s
Fingerprint Sensor Type	Capacitive
Fingerprint Verification Mode	1: N
Fingerprint Comparison Time	≤1.5s
<b>Capacity</b>	
User Capacity	100,000
Face Image Capacity	100,000
Fingerprint Capacity	10,000
Card Capacity	100,000
Password Capacity	100,000
Record Capacity	300,000 records
<b>Port</b>	
RS-485	1
RS-232	1
Wiegand	1 (input or output)
USB	2 USB2.0 port
Ethernet	1 1000M Ethernet Port 1 10M/100M Ethernet Port
Alarm Input	2 (Switch quantity)
Alarm Output	2 (Relay)
Alarm Linkage	Yes
Exit Button	1
Door Status Detection	1
Lock Control	1
<b>Alarm</b>	
Anti-Passback	Yes
Tamper	Yes
Duress	Yes
Door Sensor Timeout	Yes
Intrusion	Yes
Illegal Card Exceeding Threshold	Yes
Duress Fingerprint	Yes

## General

Power Supply	Provided
Power Supply Mode	DC 12V 2A
Protection Grade	IP65 (Silicone sealant is needed. For details, see the quick start guide.)
Power Consumption	24W
Product Dimensions	250.6mm×129.0mm×30.5mm(9.87"×5.08"×1.20")
Packaging Dimensions	Controller packaging: 380mm×235mm×124mm (14.96"×9.25"×4.88") Protective case: 494mm×402mm×275mm (19.45"×15.83"×10.83")
Working Temperature	-30°C to +50°C (-22°F to +122°F)
Working Humidity	0%RH–90%RH (non-condensing)
Working Environment	Indoor and outdoor
Gross Weight	2.0kg (4.41 lb)
Installation Method	Wall mounted
Certification	CE/FCC

## Ordering Information

Type	Model	Description
Face Recognition Access Controller (IC card; fingerprint; outdoor)	DHI-ASI7214X	7-inch Face and Fingerprint Recognition Access Controller (IC card; outdoor)
Face Recognition Access Controller (IC card; fingerprint; outdoor)	ASI7214X	7-inch Face and Fingerprint Recognition Access Controller (IC card; outdoor)

## Dimensions (mm[inch])

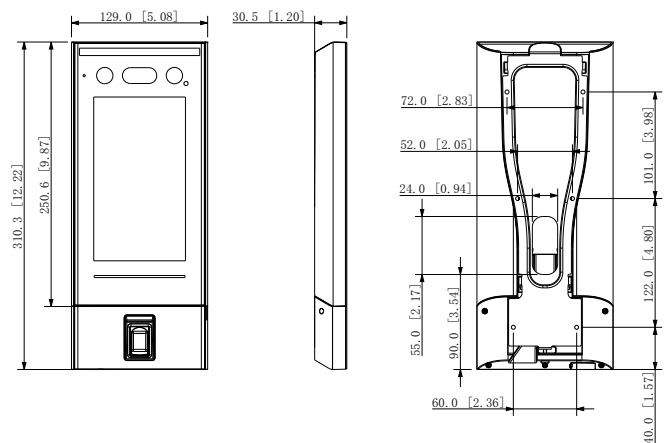

Application

